



MLS CO.,LTD.

DATA SHEET

PART NO. : 5AC2SC19

DATE :

DEPARTMENT : RD1

REVISION : A/0

<b>RECEIVED</b>			
<input checked="" type="checkbox"/> <b>MASS PRODUCTION</b>			
<input type="checkbox"/> <b>PRELIMINARY</b>			
<input type="checkbox"/> <b>CUSTOMER DESIGN</b>			
<b>DEVICE NUMBER :</b>			
<b>PAGE :</b>			
	<b>APPROVER</b>	<b>CHECKER</b>	<b>DESIGNER</b>
M.L.S			
	R&D	QA	MP
CUSTOMER			

CUSTOMER OPINION

OFFICE: THE FIRST AND SECOND BUILDING, THE FIRST CARVE OUT GARDEN PLOT,  
NORTH DONG MING,ZHONG SHAN, CHINA

TEL. : (0760)88717177

FAX : (0760)88714636

<http://www.zsmls.com>





MLS CO., LTD

Part No.: 5AC2SC19

Page: 1 of 5

Description: 5mm Round

Package Dimensions

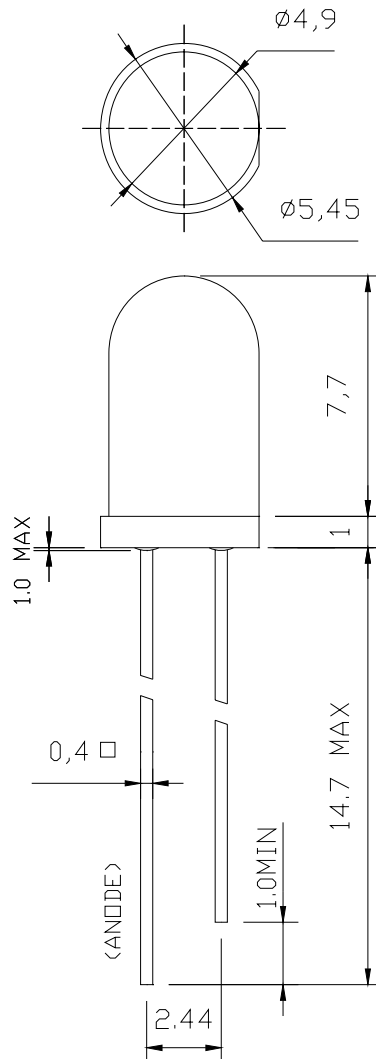

Lens	Material	Emitting Color
Water Clear	InGaN	White

NOTES

- 1.All dimensions are in millimeters .
- 2.Tolerance is  $\pm 0.25$ mm unless otherwise noted.
- 3.Protruded resin under flange is 1.0mm max.
- 4.Lead spacing is measured where the leads emerge from the package.
- 5.Specifications are subject to change without notice.



**Absolute Maximum Ratings at TA=25°C**

Parameter	Maximum Rating	Unit
Power Dissipation	130	mW
Peak Forward Current (1/10 Duty Cycle,0.1ms Pulse Width)	100	mA
DC Forward Current	30	mA
Reverse Voltage	5	V
Operating Temperature Range	-40°C to+80°C	
Storage Temperature Range	-40°C to+100°C	
Lead Soldering Temperature [1.6mm(.063") From Body]	320°C for 5 seconds	

**Electrical Optical Characteristics at TA=25°C**

Parameter	Symbol	Min.	Typ.	Max.	Unit	Test Condition
Luminous Intensity	I <sub>v</sub>	6000	/	/	mcd	IF=20mA
Viewing Angle	2 θ 1/2		15		deg	IF=20mA
Peak Emission Wavelength	λ <sub>p</sub>			460	nm	IF=20mA
Chromaticity coordinate	X/Y	0.21/0.22	0.26/0.27	0.31/0.32	nm	IF=20mA
Spectral Line Half-Width	Δ λ		30		nm	IF=20mA
Forward Voltage	V <sub>F</sub>	2.8	3.2	3.8	V	IF=20mA
Reverse Current	I <sub>R</sub>			40	μ A	VR=5V

**Note:** 1.Luminous intensity is measured with a light sensor and filter combination that approximates CIE (Commission International Dd L Eclairage)eye-response curve.

2. θ 1/2 is the off-axis angle at which the luminous intensity is half the axial luminous intensity.
3. The dominant wavelength, λ<sub>d</sub> is derived from the CIE chromaticity diagram and represents the single wavelength which defines the color of the device.
- 4.The I<sub>v</sub> guarantee should be added ± 15%.

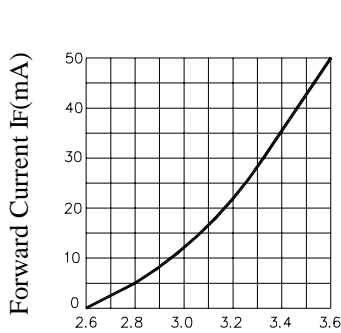
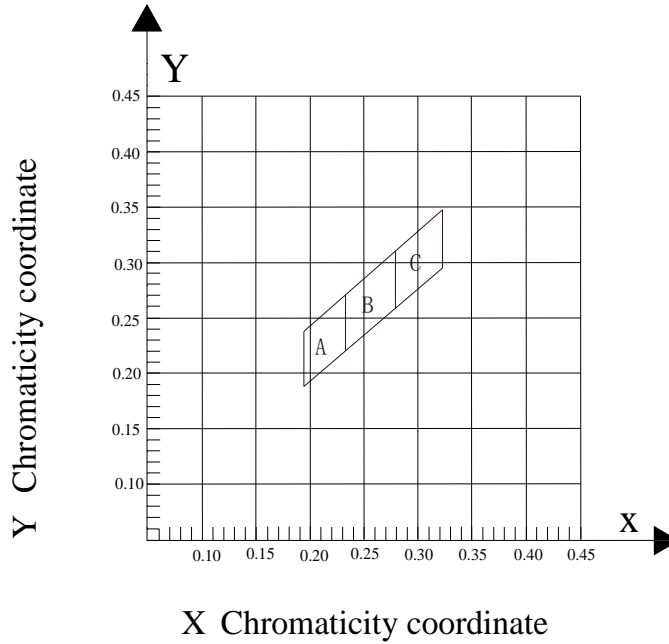

Forward Voltage  $V_f$ (V)  
Fig.2 Forward Current vs. Forward Voltage

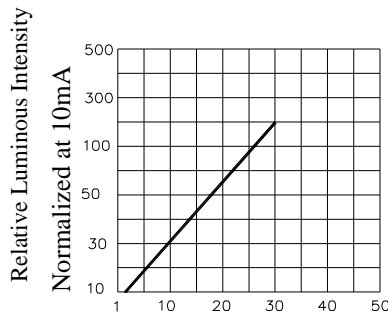

Forward Current(mA)  
Fig.4 Relative Luminous Intensity vs. Forward Current

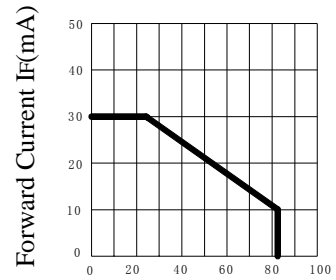

Ambient Temperature  $T_A$ (°C)  
Fig.3 Forward Current Derating Curve

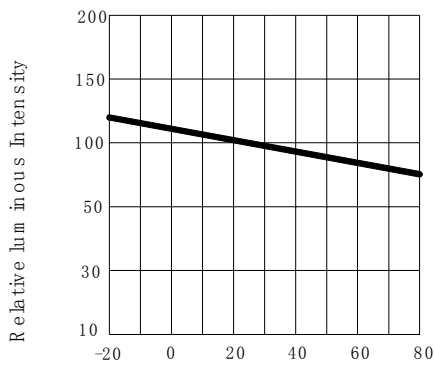

Ambient Temperature  $T_A$ (°C)  
Fig.5 Luminous Intensity vs Ambient Temperature

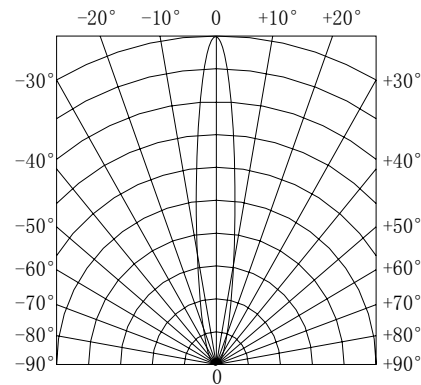

Emitted Angle 15°  
Fig.6 Spatial Distribution



**CAUTIONS**

**1.Application**

The LEDs described here are intended to be used for ordinary electronic equipment (such as office equipment, communication equipment and household applications).Consult MLS's Sales in advance for information on applications in which exceptional reliability is required, particularly when the failure or malfunction of the LEDs may directly jeopardize life or health(such as in aviation ,transportation, traffic control equipment, medical and life support systems and safety devices)

**2.Storage**

The storage ambient for the LEDs should not exceed 30°C temperature or 70% relative humidity.

It is recommended that LEDs out of their original packaging are used within three months.

For extended storage out of their original packaging,it is recommended that the LEDs be stored in a sealed container with appropriate desiccant or in desiccators with nitrogen ambient.

**3. Cleaning**

**4.Lead Forming & Assembly**

During lead forming, the leads should be bent at point at least 3mm from the base of LED lens.

Do not use the base of the lead frame as a fulcrum during forming.

Lead forming must be done before soldering,at normal temperature.

During assembly on PCB, use minimum clinch force possible to avoid excessive mechanical stress.

**5.Soldering**

When soldering leave a minimum of 2mm clearance from the base of the lens to the soldering point.

Dipping the lens into the solder must be avoided.

Do not apply any external stress to the lead frame during soldering while the LED is at high temperature.

Recommended soldering conditions:

Soldering iron		Wave soldering	
Temperature	320°C Max	Pre-heat	100°C Max
Soldering time	3 sec.Max (one time only)	Pre-heat time	60sec.Max
		Solder wave	260°C Max
		Soldering time	8sec.Max

Note:Excessive soldering temperature and/or time might result in deformation of the LED lens or catastrophic failure of the LED.

**6.Drive Method**

An LED is a current-operated device,In order to ensure intensity uniformity on multiple LED: connected in parallel in an application,it is recommended that a current limiting resistor be incorporated in the drive circuit,in series with each LED as shown in Circuit A below.

Circuit model A

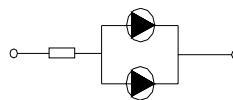
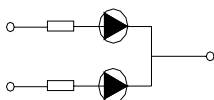

(A)Recommended circuit

(B)The brightness of each LED might appear different due to the differences in the I-V characteristics of those LEDs.

**7.Protect Of ESD**

Since the device is static sensitive,it is requested that anti-static measures should be taken on human body,all devices (including soldering iron) and equipment,machinery,desk and ground.



**8. Reliability Test**

Classification	Test Item	Ta=Under Room Temperature As	Sample Size	Ac/Re
Endurance Test	Operation Life	Per Data Sheet Maximum Rating *Test Time=1000HRS(-24HRS,+72HRS)	22PCS	0/1
	High Temperature Storage	Ta=100±5°C *Test Time=1000HRS(-24HRS,+72HRS)	22PCS	0/1
	Low Temperature Storage	Ta=-40±5°C *Test Time=1000HRS(-24HRS,+72HRS)	22PCS	0/1
Environmental Test	Temperature Cycling	85°C ~ 25°C ~ -40°C ~ 25°C 30mins 5mins 30mins 5mins 10Cycles	22PCS	0/1
	Thermal Shock	85°C±5°C ~ -40°C±5°C 10mins 10mins 10Cycles	22PCS	0/1
	Solder	T.sol=260°C±5°C Dwell Time=10±1secs	22PCS	0/1

**9. Others**

The appearance and specifications of the product may be modified for improvement, without prior notice.